

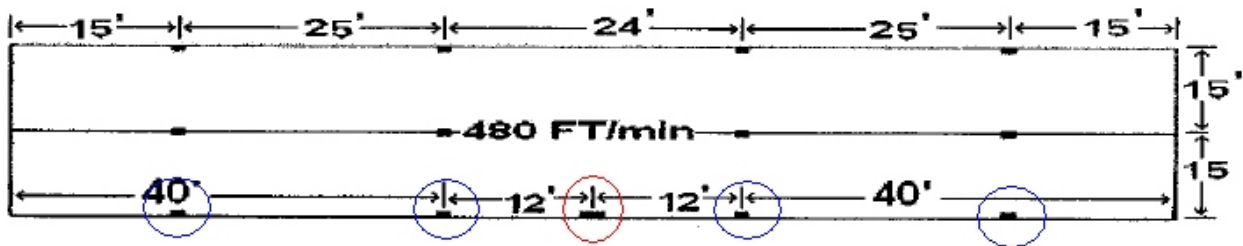

### Questions & Answers for interpretation of PI-07

For questions related to Option B and B1, see Q & A #1 to 15.  
For questions related to Option E, see Q & A #16 and 17.  
For questions related to power outage, see Q and A #18.

#### Q-1 : Can this facility be approved to operate option B?



Dry Bulbs  
Wet Bulb

A-1 : Yes

Requirements Option B	This facility	Conform
At least one wet bulb located near the midpoint of the heat chamber	One wet bulb located at the midpoint of the heat chamber	Y
At least one dry bulb located near the midpoint of the heat chamber	There are 4 dry bulbs located on the same side in the kiln. There is no dry bulb at the midpoint but the 4 dry bulbs compensate for the one that is supposed to be at the midpoint.	Y

**Q-2 : Can this facility be approved to operate option B 1**

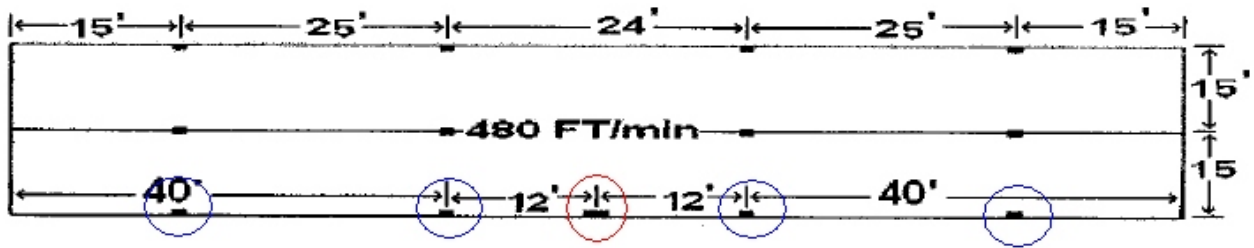

Dry bulbs  
Wet bulb

A-2 : Yes

Requirements Option B 1	This facility	Conform
At least one wet bulb located near the midpoint of the heat chamber	One wet bulb located at the midpoint of the heat chamber	Y
At least 3 dry bulbs located on either side of the heat chamber. Sensors must be spaced approximately at equal distance apart perpendicularly to the air flow. One Sensor must be located at each end and must be placed closest to the end (apprx < 5m (16,5 feet))	12 dry bulbs located at different points in the kiln. 2 of them are situated at each end of the heat chamber (15 feet from each door). In this case, there are also 4 dry bulbs on one side of the heat chamber approximately at equal distance apart.	Y

**Q-3 :Can this facility be approved under option B ?**

O Indicates Wet Bulb  
 X Indicates Dry Bulb

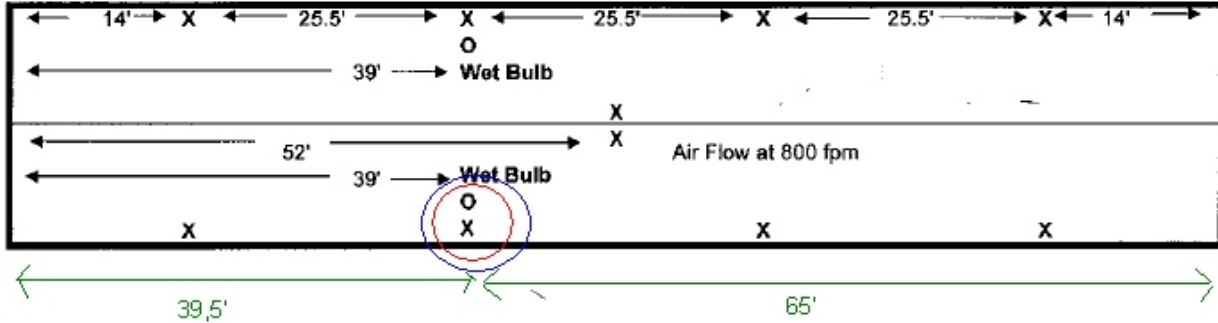

Dry bulbs  
 Wet bulb

A-3 : Yes

Requirements Option B	This facility	Conform
At least one wet bulb located near the midpoint of the heat chamber	One wet bulb located in the third section of the heat chamber	Y
At least one dry bulb located near the midpoint of the heat chamber	One dry bulb located in the third section of the heat chamber	Y

**Q-4 : Can this facility be approved to operate under option B1 ?**

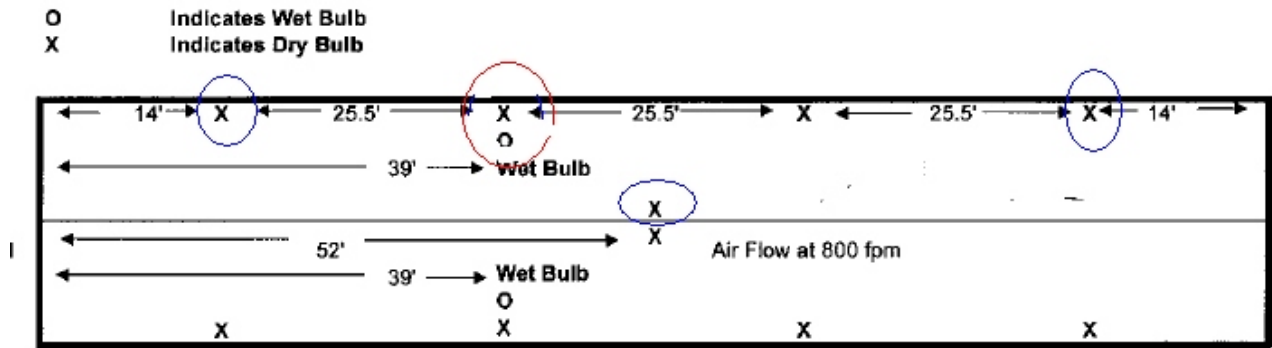

Dry Bulbs

Wet Bulb

A-4 : Yes

Requirements Option B 1	This facility	Conform
At least one wet bulb located near the midpoint of the heat chamber	One wet bulb located in the third section of the heat chamber	Y
At least 3 dry bulbs located on either side of the heat chamber. Sensors must be spaced approximately at equal distance apart perpendicularly to the air flow. One Sensor must be located at each end and must be placed closest to the end (apprx < 5m (16,5 feet))	Two dry bulbs are situated at each end of the heat chamber (14 feet from each door). One dry bulb is situated in the mid point so we have at least 3 dry bulbs situated at equal distance apart.	Y

**Q-5 : Can this facility be approved to operate under option B ?**

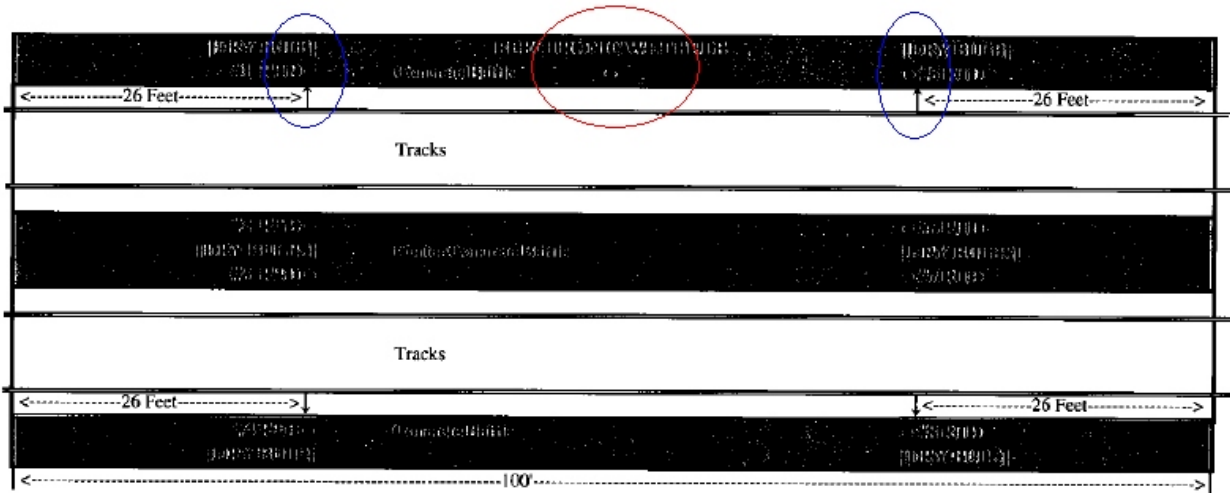

Dry Bulbs  
Wet Bulb

A-5: Yes

Requirements Option B	This facility	Conform
At least one wet bulb located near the midpoint of the heat chamber	One wet bulb located at the midpoint of the heat chamber	Y
At least one dry bulb located near the midpoint of the heat chamber	There are 2 dry bulbs located on the same side in the kiln. There is no dry bulb at the midpoint but the 2 dry bulbs compensate for the one that is supposed to be at the midpoint.	Y

**Q-6: Can this facility be approved to operate under option B?**

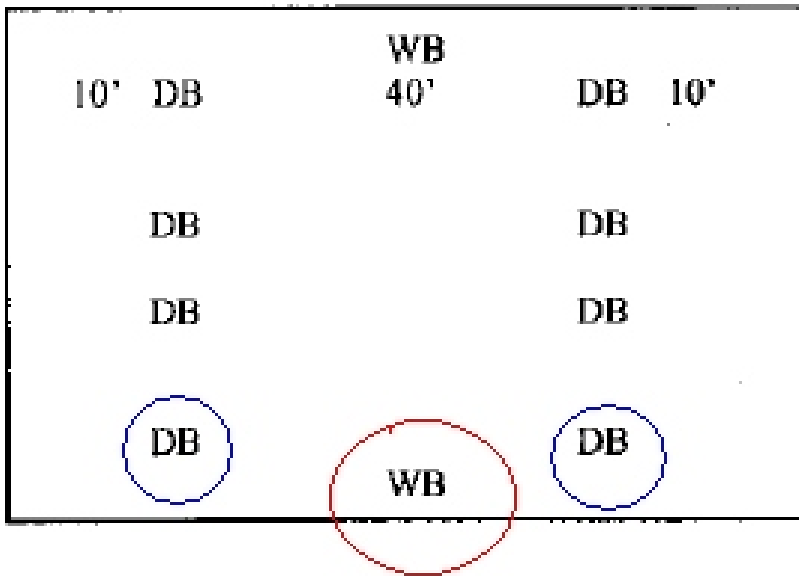

Dry Bulbs  
Wet Bulb

A- 6: Yes

Requirements Option B	This facility	Conform
At least one wet bulb located near the midpoint of the heat chamber	One wet bulb located at the midpoint of the heat chamber	Y
At least one dry bulb located near the midpoint of the heat chamber	There are 2 dry bulbs located on the same side in the kiln. There is no dry bulb at the midpoint but the 2 dry bulbs compensate for the one that is supposed to be at the midpoint.	Y

**Q-7: Can this facility be approved to operate under option B ?**

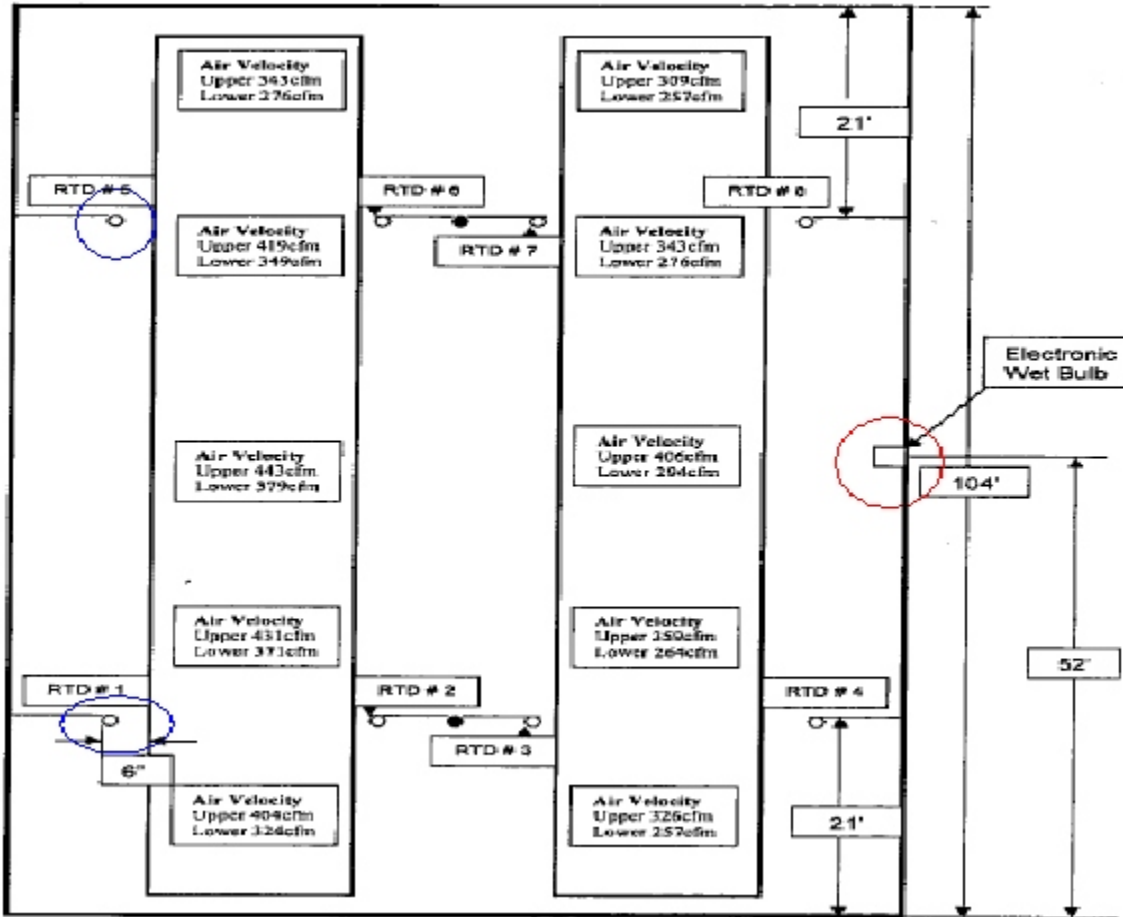

Dry Bulbs

Wet Bulb

A- 7: Yes

Requirements Option B	This facility	Conform
At least one wet bulb located near the midpoint of the heat chamber	One wet bulb located at the midpoint of the heat chamber	Y
At least one dry bulb located near the midpoint of the heat chamber	There are 2 dry bulbs located on the same side in the kiln. There is no dry bulb at the midpoint but the 2 dry bulbs compensate for the one that is supposed to be at the midpoint.	Y

**Q-8: Can this facility be approved to operate under option B ?**

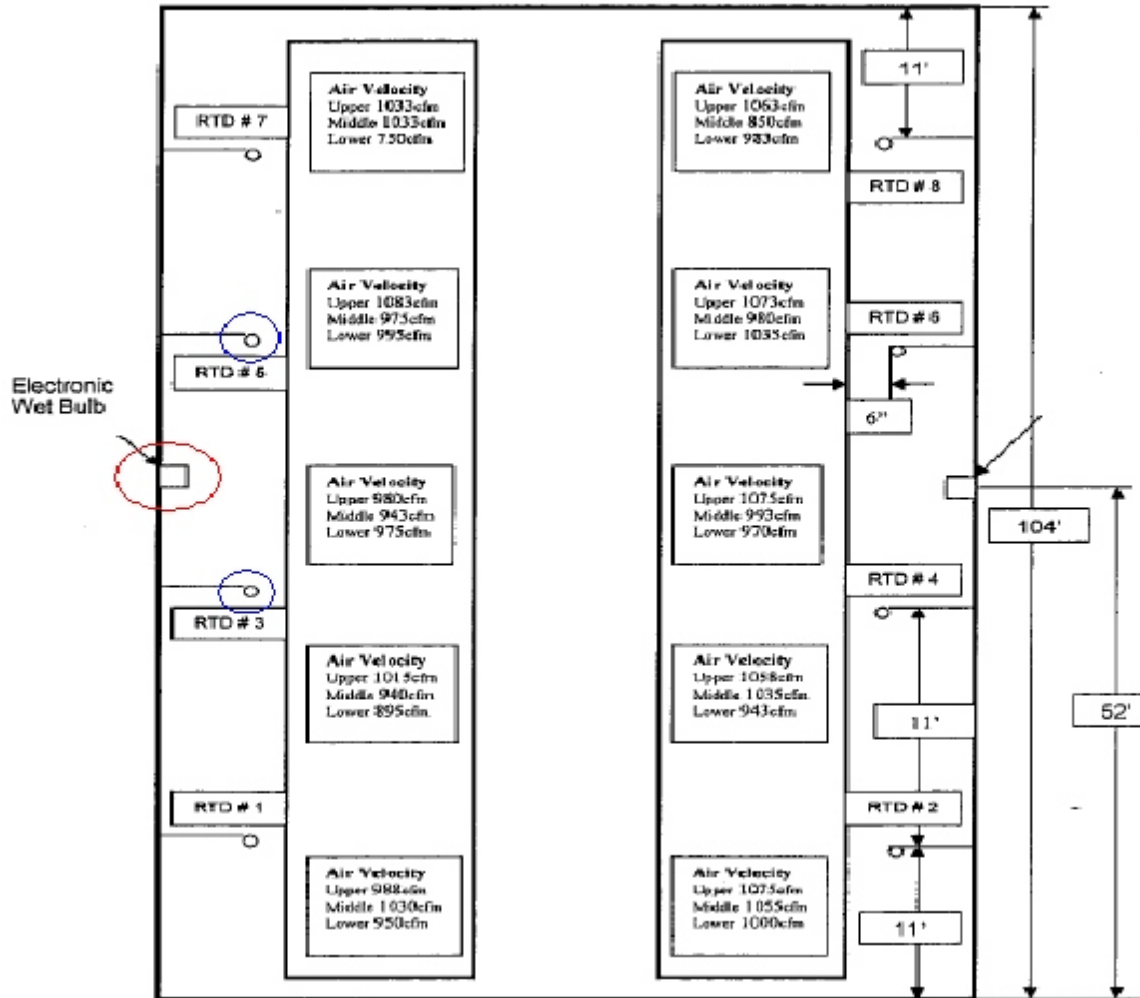

Dry Bulbs  
Wet Bulb

A-8 : Yes

Requirements Option B	This facility	Conform
At least one wet bulb located near the midpoint of the heat chamber	One wet bulb located at the midpoint of the heat chamber	Y
At least one dry bulb located near the midpoint of the heat chamber	There are 2 dry bulbs located on the same side in the kiln. There is no dry bulb at the midpoint but the 2 dry bulbs compensate for the one that is supposed to be at the midpoint.	Y



**Q-9 : Which option could a facility use to heat treat a piece of wood of 6"x 6" ?**

A-9: The PI-07 includes two options that a facility could use to heat treat wood of large dimensions, Option A for coniferous (softwood) species and Option E for all deciduous (hardwood) genera.

**Q - 10: Can this facility be approved to operate Option B1**

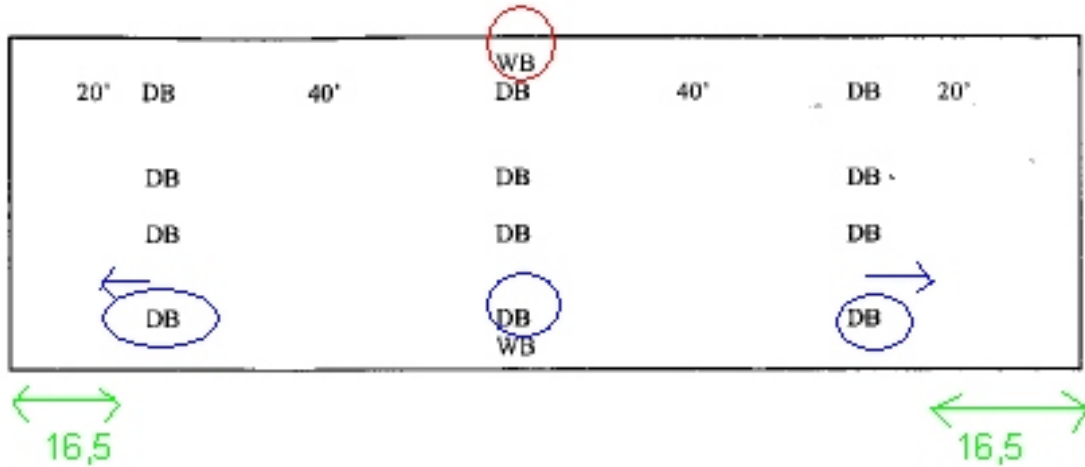

Dry bulbs  
Wet bulb

A- 10: No

Requirements Option B 1	This facility	Conform
At least one wet bulb located near the midpoint of the heat chamber	One wet bulb located at the midpoint of the heat chamber	Y
At least 3 dry bulbs located on either side of the heat chamber. Sensors must be spaced approximately at equal distance apart perpendicularly to the air flow. One Sensor must be located at each end and must be placed closest to the end (apprx < 5m (16,5 feet))	The two dry bulbs situated near the doors have to be moved. They need to be placed at a maximum distance of 16,5' from the doors.	N

**Q-11 : Can this facility be approved under option B1 ?**

Dry bulbs

Wet bulb

A-11 : No

Requirements Option B 1	This facility	Conform
At least one wet bulb located near the midpoint of the heat chamber	One wet bulb located at the midpoint of the heat chamber	Y
At least 3 dry bulbs located on either side of the heat chamber. Sensors must be spaced approximately at equal distance apart perpendicularly to the air flow. One Sensor must be located at each end and must be placed closest to the end (apprx < 5m (16,5 feet))	The two dry bulbs situated near the doors have to be moved. They need to be placed at a maximum distance of 16,5' from the doors. A dry bulb has to be added at the midpoint of the kiln to have 3 dry bulbs at equal distance apart.	N

**Q-12 : Can this facility be approved under option B1?**

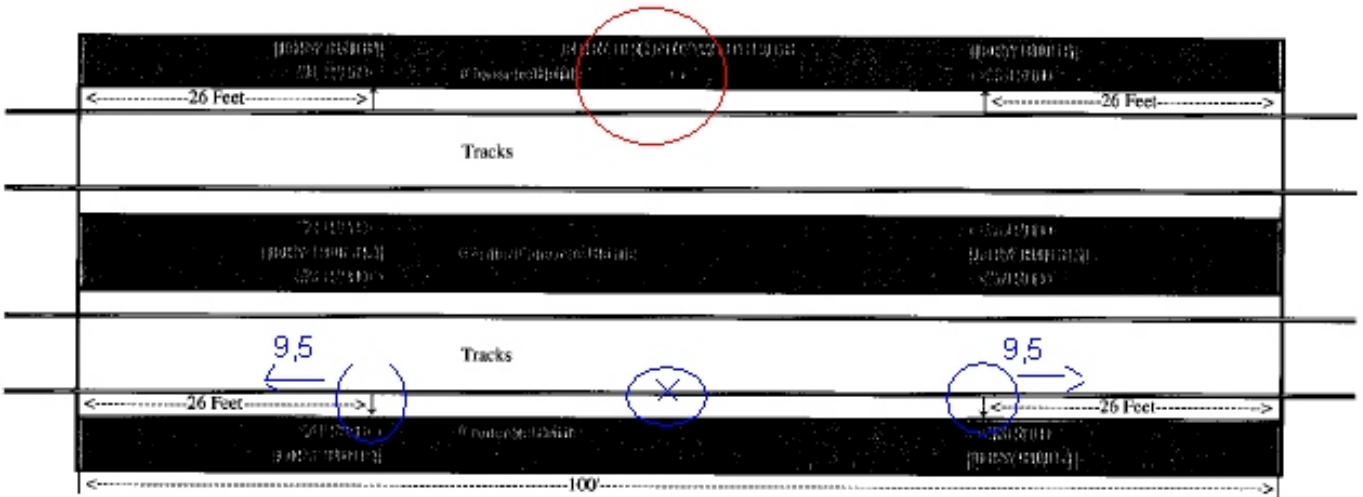

Dry bulbs

Wet bulb

A-12: No

Requirements Option B 1	This facility	Conform
At least one wet bulb located near the midpoint of the heat chamber	One wet bulb located at the midpoint of the heat chamber	Y
At least 3 dry bulbs located on either side of the heat chamber. Sensors must be spaced approximately at equal distance apart perpendicularly to the air flow. One Sensor must be located at each end and must be placed closest to the end (apprx < 5m (16,5 feet))	The two dry bulbs situated near the doors have to be moved. They need to be placed at a maximum distance of 16,5' from the doors. A dry bulb has to be added at the midpoint of the kiln to have 3 dry bulbs at equal distance apart.	N

**Q-13 : Can this facility be approved to operate under option B1?**

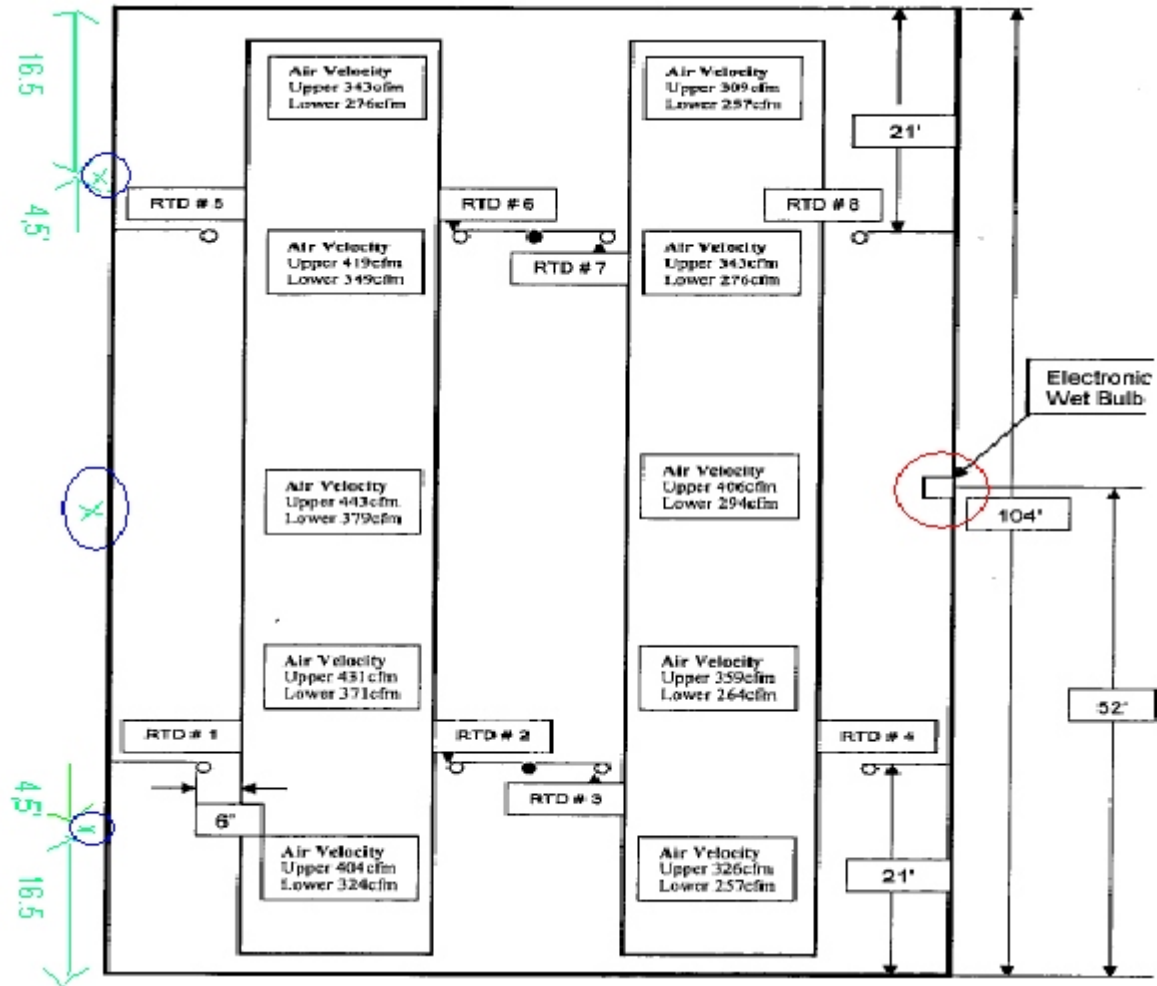

Dry bulbs  
Wet bulb

A-13 : No

Requirements Option B 1	This facility	Conform
At least one wet bulb located near the midpoint of the heat chamber	One wet bulb located at the midpoint of the heat chamber	Y
At least 3 dry bulbs located on either side of the heat chamber. Sensors must be spaced approximately at equal distance apart perpendicularly to the air flow. One Sensor must be located at each end and must be placed closest to the end (apprx < 5m (16,5 feet))	The two dry bulbs situated near the doors have to be moved. They need to be placed at a maximum distance of 16,5' from the doors. A dry bulb has to be added at the midpoint of the kiln to have 3 dry bulbs at equal distance apart.	N

**Q-14: Can this facility be approved to operate under option A ?**

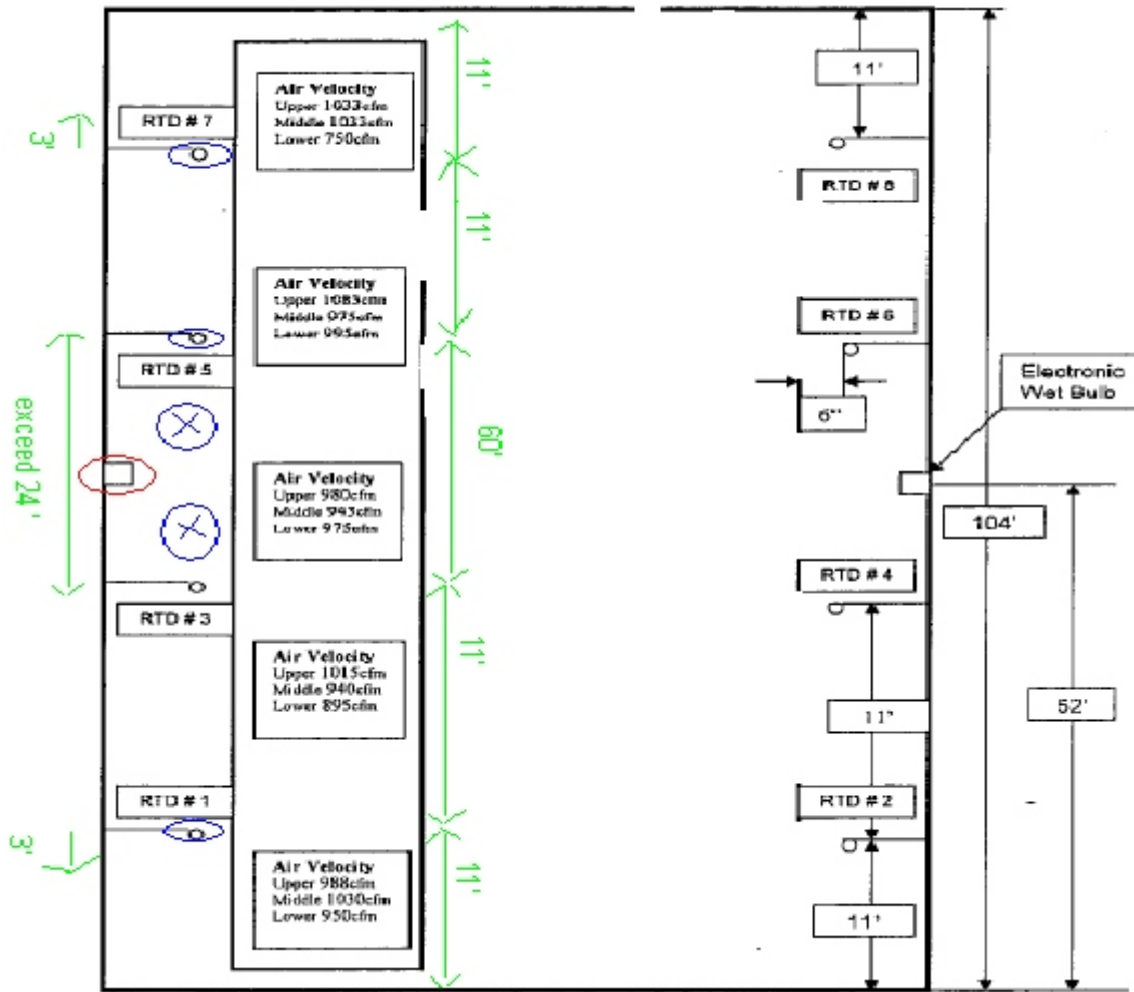

Dry bulbs  
Wet bulb

A- 14: No

Requirements Option A	This facility	Conform
At least one wet bulb located near the midpoint of the heat chamber	One wet bulb located at the midpoint of the heat chamber	Y
Dry bulb must be spaced not more than 24 feet apart with one located no more than 8 feet from each end of the treatment chamber. The number of dry bulbs will depend on the length of the individual kiln.	The dry bulb near the end of the heat treatment chamber has to be moved (3 ft) to respect the requirement (8ft from each end). 2 dry bulbs have to be added to meet the requirement of no more than 24 ft apart.	N

**Q-15: Can this facility be approved to operate under option B1 ?**

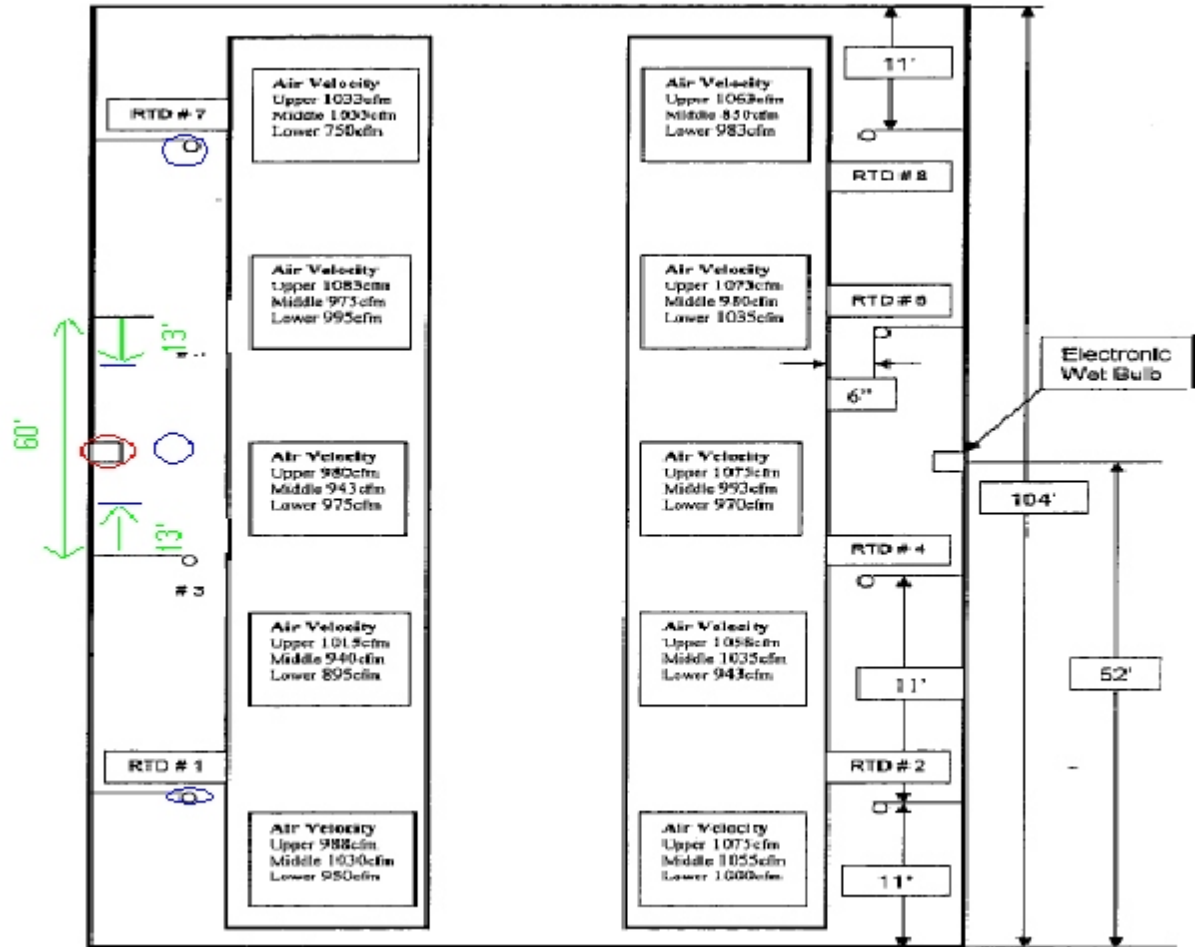

Dry bulbs    Wet bulb

A-15 : No

Requirements Option B 1	This facility	Conform
At least one wet bulb located near the midpoint of the heat chamber	One wet bulb located at the midpoint of the heat chamber	Y
At least 3 dry bulbs located on either side of the heat chamber. Sensors must be spaced approximately at equal distance apart perpendicularly to the air flow. One Sensor must be located at each end and must be placed closest to the end (apprx < 5m (16,5 feet))	The two dry bulbs situated near the doors meet the requirement. In order to meet the rule of equal distance between sensors, a dry bulb has to be located at the midpoint and there is no dry bulb at this place. One of the dry bulbs (#3,4,5 or 6) has to be moved in the central part (1/3) to meet the requirement .	

Q-16. Does the following kiln layout meet the mandatory operating conditions for Option E, PI-07?

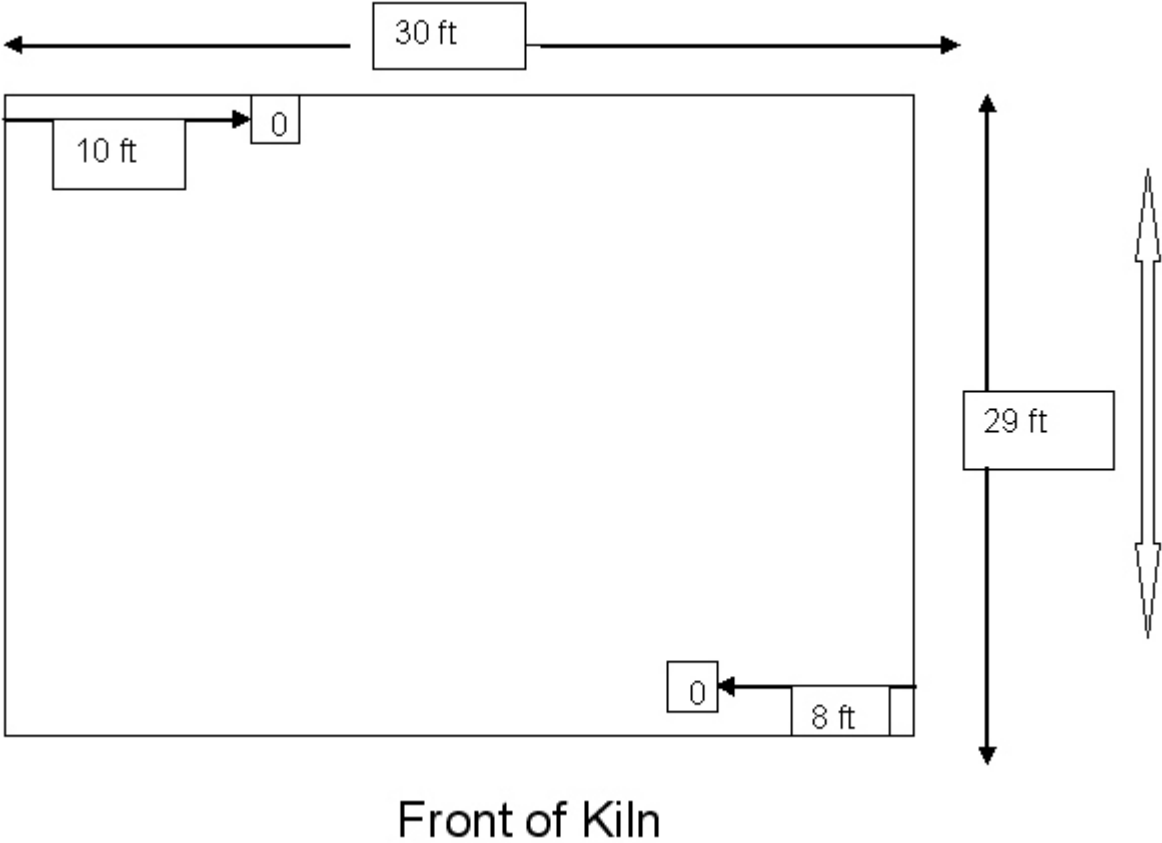

“0” signifies location of EMC and Dry Bulb Station

↔ signifies direction of air flow

A.-16. No.

For this kiln, sensor at the back of the kiln must be moved 2-ft closer to the side wall i.e. to the left in the diagram. This would meet the needs of the requirement. If these are wireless probes that should not be a problem. The only other thing is that one sensor is located on one side of the load and the other is on the opposite side. Since the schedule calls for monitoring the temperature on the entry side of the load, the readings from these sensors will only be considered when the air is entering on that side of the load.

Q-17. Does the following kiln layout meet the mandatory operating conditions for Option E, PI-07?

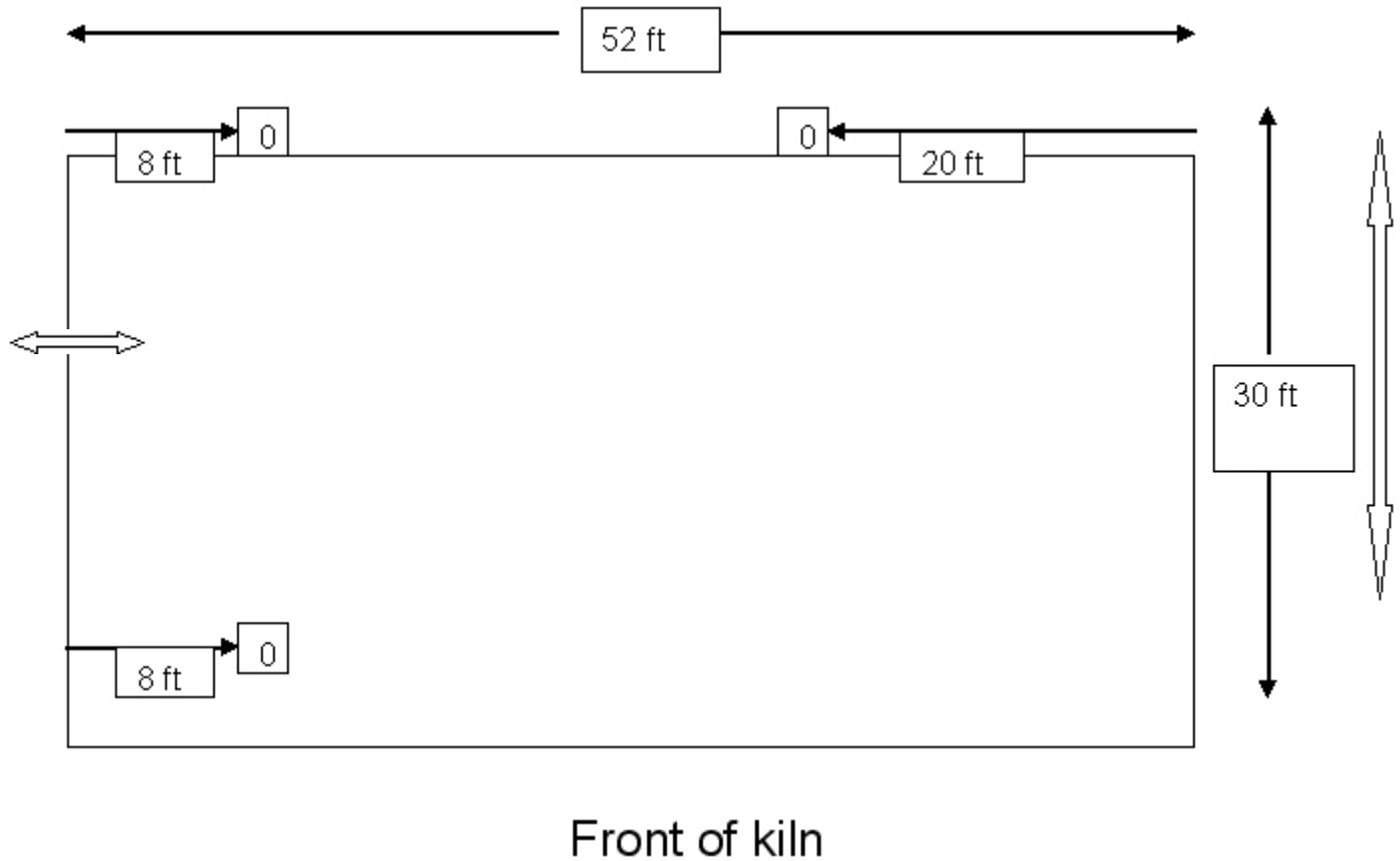

“0” signifies location of EMC and Dry Bulb Station

 signifies direction of air flow

A.-17. No.

In this case, the kiln is much wider and would need at least three sensors to cover the full length/width of the kiln. In this case, the sensor at the back of the kiln (on the right hand side) must be moved over to the mid-point of the back wall i.e. 26-ft. from either wall. The sensor at the front of the kiln could then be moved over to within 8-feet of the right hand wall. In this manner they would have a sensor within 8-ft of either wall and the lateral distance between the sensors at the sides and the sensor at the mid-point of the kiln would be approximately 18-feet.



Q.-18 How should a facility deal with a power outage during kiln operations?

A.-18

In the event of a power outage a case by case evaluation of the interruption will be done by the Grading Agency (GA). If the GA needs further confirmation, the GA will submit the kiln records to the CLSAB for their approval. If further review is required it would be submitted to a Technical Panel formed by representatives from CFIA, CLSAB and a Technical 3rd. party.